

AN EVALUATION OF SOIL AERATION STATUS AROUND HEALTHY AND DECLINING OAKS IN AN URBAN ENVIRONMENT IN CALIFORNIA

by J.D. MacDonald, L.R. Costello¹ and T. Berger

Abstract. Examination of soil conditions around healthy and declining oak trees in an urban area in California revealed that soil aeration in the upper soil strata was critical to tree vigor. It also was found that measurements of oxygen diffusion rate gave a better indication of oxygen availability in soil than measurements of oxygen concentration. Oxygen diffusion rate was lowest in soils with high bulk density and high soil moisture content. In a poorly-aerated soil, oxygen diffusion rate did not increase significantly following air injections designed to loosen soil structure.

Poor soil aeration is frequently cited by tree care professionals as the cause of tree decline. Trees are diagnosed as suffering from "wet feet", "suffocation", "anoxia", "oxygen stress", etc., all of which are terms descriptive of poor soil aeration.

Often there is a reasonable basis for the diagnosis of poor aeration. It is understood that roots require oxygen for proper function, and that oxygen moves from the atmosphere to roots primarily by diffusion through the soil. When soil has numerous, large-diameter pores, oxygen diffusion is rapid. Conversely, if soil contains few large-diameter pores, diffusion is inhibited. Healthy root function, therefore, requires a soil structure that enhances oxygen diffusion.

It is apparent, however, that conditions exist in the root zone of many trees that interfere with oxygen diffusion into and through soils. For example, fine-textured soils (such as clays) or compacted soils have fewer macropores to support rapid diffusion; excessive soil moisture causes pores to be filled with water (through which oxygen diffuses very slowly); surface barriers such as asphalt or concrete may slow the rate of oxygen entry into soil; and grade changes (fill soils) increase the distance over which oxygen must diffuse to reach an established root system. These and other conditions exist in many treescapes and frequently lead to the conclusion that tree decline

is the result of poor aeration.

The frequent occurrence of factors that may cause (or lead to) restricted oxygen movement in urban treescapes has prompted arborists and planners to employ a number of practices and design strategies to enhance soil aeration. These include venting systems to alleviate the effects of grade changes, porous pavers as substitutes for asphalt or concrete, core venting and vertical mulching to open large air channels, and high pressure water or air injections (e.g., Grow Gun[®]) to fracture compacted zones. There is, however, very little experimental evidence indicating whether these strategies successfully protect or enhance soil aeration within tree root systems. In fact, some fundamental questions remain uncertain, including:

- 1) What oxygen levels are critical for normal root function in landscape trees?
- 2) What are the proportionate contributions of various soil factors (high bulk density, high soil moisture, etc.) to reduced oxygen availability?
- 3) How effective are aeration-enhancement procedures in achieving or maintaining soil oxygen levels above critical thresholds, and what are the dimensions of their "sphere of influence" within the soil mass?
- 4) How do different soils respond to aeration-enhancement procedures?

These and many other questions are appropriate when assessing aeration effects on tree health or prescribing treatment procedures. However, to answer these questions, we need to ask more basic questions: A) what is the most relevant measure of soil oxygen status within tree root zones?; B) what variation in oxygen status exists around urban trees?. The research reported here was undertaken to address these questions. Our

¹U.C. Cooperative Extension, 625 Miramontes St., Half Moon Bay, CA 94019

specific objectives were to measure soil oxygen within the root zones of healthy and declining trees using two common analytical methods, and to relate tree condition to soil oxygen status and certain physical features of the soil environment. It was hoped that this would lead to an effective protocol for assessing soil oxygen status and the efficacy of treatment procedures.

Materials and Methods

Measurement of soil oxygen and oxygen diffusion rate status. The oxygen concentration in soil gas samples (percent O₂ by volume) was determined with a Carle model 8500 gas chromatograph (EG&G Engineering, Tulsa, OK). Gas samples were collected from various depths in soil profiles using probes similar in design to those of Rolston (10). Each probe was fabricated from 2.5-cm-diameter PVC plastic tubing, into which a tight-fitting rubber stopper was pushed from one end to a depth of 10 cm. This formed a closed chamber with a volume of approximately 30 cm³ at one end of the tube. Before the stopper was pushed into the tube, a small hole was drilled through its center and a 1-mm-diameter nylon capillary tube was inserted. One end of the capillary tube projected 1-2 cm into the chamber formed by the stopper, and the other protruded 4-6 cm out the open end of the PVC tube. Silicone glue was used to seal both sides of the stopper where the capillary tube passed through it. A silicon rubber septum was fitted over the long, exposed end of the capillary tube.

Probes were made to 15, 30 or 100 cm lengths. They were inserted (chamber end down) into 2.5-cm-diameter holes that were drilled in the soil to the desired depth. Soil around the upper, exposed ends of the probes was tightly packed against the plastic tubes to seal the insertion channels. After installation, the probe chambers were purged of atmospheric air by inserting a syringe into the septum attached to the capillary tube and extracting a 30 cm³ volume of air.

Soil oxygen diffusion rate (ODR) was measured using a Jensen Instruments (2021 South Seventh St., Tacoma, WA) model D oxygen diffusion ratemeter. Platinum microelectrodes (15, 30, or 100 cm in length) were inserted into soil after

pilot holes were drilled to the desired depth with a hardened steel rod having a diameter equal to that of the electrodes. All sites in this study had trees growing in irrigated turf, so there was adequate moisture in the soil profile to wet the platinum electrode tips (1).

Study sites. Six landscape sites on the UC Davis campus were selected for soil oxygen measurement. Each was distinguished by having apparently healthy or declining oak trees. The sites were:

Site 1. A large, open, heavily-trafficked (foot) turf field with a row of 50+ year-old cork oaks (*Quercus suber*) growing around the perimeter. Paved roads lay just outside the tree perimeter and approximately 25% of the trees appeared chlorotic with thinning canopies.

Site 2. A moderately-trafficked turf area with coast live oak (*Q. agrifolia*) growing fully within the irrigated turf. The two trees examined at this site were in severe decline (chlorosis, canopy thinning) and subsequently died.

Site 3. A lightly-trafficked turf parking strip (2-3 m wide), bordered by a curb and paved road on one side and a paved bike path and fallow field on the other. A row of 20+ year-old cork oaks were growing in the strip and all appeared healthy and vigorous (no chlorosis, full canopies)

Site 4. A moderately-trafficked turf area surrounding a large (50-75 year-old) coast live oak. The single tree at this site showed some chlorosis and extensive canopy thinning.

Site 5. A lightly-trafficked turf parking strip (3 m wide, bordered by a sidewalk and paved road on one side, and a paved bicycle parking area on the other) planted with a row of 20+ year-old cork oaks. The tree examined at this site exhibited severe chlorosis and some canopy thinning.

Site 6. A moderately-trafficked turf area surrounding a 20+ yr-old coast live oak. The tree at this site was slightly chlorotic with no canopy thinning.

At each site, three replicate monitoring locations were established. Within each monitoring location, a tensiometer, a gas sampling tube (field sites 1 and 2 only), and five platinum microelectrodes were installed to each of three depths: 15, 30 and 100 cm. Soil matric potentials and ODR values

were measured daily, at the same time each day, over intervals of two weeks. Gas samples (3 cm³) were extracted at 4-5 day intervals, allowing time for air within the chambers to equilibrate with the soil atmosphere. All ODR microelectrodes were removed for cleaning and inspection after 14-16 days in the ground (1). If continued measurements were desired, fresh electrodes were inserted into the same holes, but were pushed 1-2 cm deeper into the soil to assure that the platinum tips made proper soil contact. Daily monitoring then was resumed for an additional 14-16 days. Sensing equipment was installed beneath the tree canopy, approximately half way between the dripline and trunk.

Soil characterization. Undisturbed soil cores (7.6 cm diameter) were collected from the 15, 30 and 100 cm depths at each field site using an Uhland soil sampler (Technical Services, Utah State University). The cores were placed inside 9-cm-diameter Büchner funnel tension plates and fully saturated with degassed water. The moisture release curve for each core was determined by subjecting it to a range of increasing tensions (0 to -30 centibars) and determining the volume of water extracted at each tension. After determining moisture release curves, the cores were removed from the tension plates, oven-dried, and weighed to determine bulk density. Finally, weighed subsamples of the dried cores were dispersed in a sodium-hexametaphosphate solution and particle size analysis was done using a hydrometer (4).

Root length density measurements. At two sites, additional undisturbed cores were collected at each depth to allow measurements of root length density. Roots were recovered from cores (which were of known volume) by wet-sieving. This was accomplished by placing each core sample in a plastic tub containing water. After allowing the soil to soften for several hours, cores were placed on #20 sieves (0.85 mm mesh openings) and sprayed with water to wash away the soil. Roots retained on the mesh were recovered by hand and placed on moist, white paper towels.

The total length of all recovered root fragments from each core was measured using a Decagon

Devices (Pullman, WA) Dias II Agvision image analysis system. Root samples were distributed across the wet paper towels to minimize clumping and overlap. Samples were back-lighted for maximum contrast and each sample was imaged and processed twice (samples were rotated 90 degrees on the illumination stage between images). Root lengths were taken from the average of the two readings.

Soil aeration treatments. An experiment was done (at site 6) to determine the effect of high pressure air injection (Gro-Gun[®]) on soil ODR. An array of ODR probes was inserted into soil at depths of 15, 30 and 100 cm. Air injection points were drilled around this array (Fig. 1) to provide maximum soil fracture within the array. The Gro-Gun[®] was fitted with a 12 inch tapered stem which was inserted and wedged into each augured hole for subsurface air injection. Air at 100 psi (from an Ingersol Rand compressor) was injected into the soil through a series of short pulses (10-15 individual pulses, totaling approximately 10 sec per injection point) until no additional soil heaving could be observed by the operator. No materials other than air were injected into the soil, and the augured holes were left open after treatment. Soil ODR and matric potential were measured daily for five days prior to injection. Measurements were repeated immediately after the air injection treatment, and for seven days thereafter.

Results and Discussion

At site 1, we measured soil ODR, O₂ concentration, and matric tension over a 16 day period. The turf at this site was irrigated four days per week, resulting in sustained, high soil moisture conditions. At the 15 and 30 cm depths, water content fluctuated with irrigation episodes, but stayed within -4 to -40 cb (Figs 2A, 2B, respectively). At the 100 cm depth, there was little fluctuation in water content, staying generally between -15 and -25 cb (Fig. 2C).

At the 15 cm depth, O₂ concentration ranged between 12 and 18% over the 16 day sampling period (Fig. 2A). Slightly lower concentrations were observed at 30 and 100 cm, ranging between 8-15% and 10-15%, respectively (Figs. 2B, 2C). Roots are sensitive to O₂ deficits: uptake of

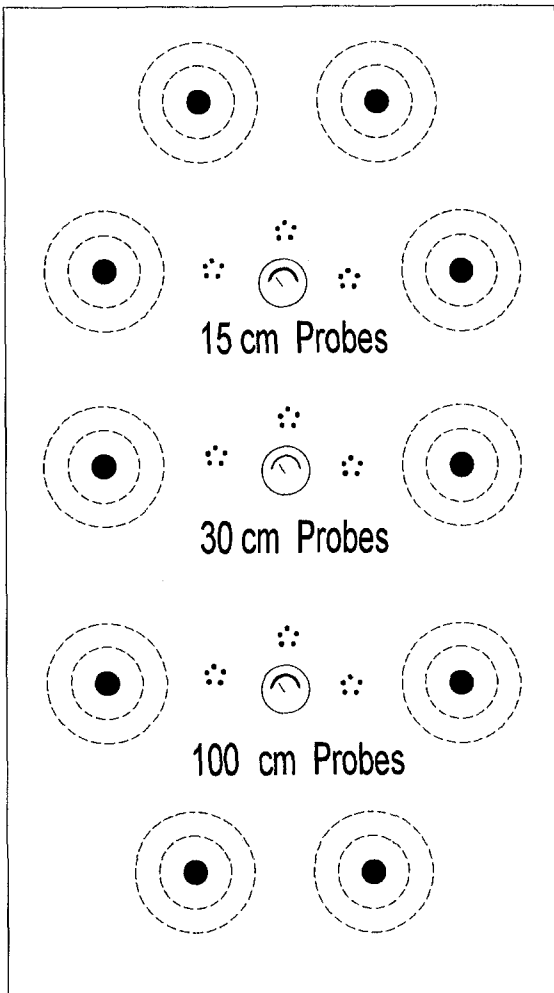

Fig. 1. Illustration of aeration enhancement experiment. ODR probes (small black dots) were inserted in three clusters of five probes at each soil depth (15, 30 and 100 cm). A tensiometer (illustrated by dial face) was installed at each depth location. Ten holes were bored around the probe array (large black dots) and 100 psi air was injected using a Gro-Gun® to fracture and lift the soil surface (illustrated by radiating dashed lines).

mineral nutrients may be impaired at $\leq 15\%$ O_2 , root initiation may be inhibited at $\leq 12\%$ O_2 , and growth may cease at $\leq 5\%$ O_2 (12). Although trees at this site were apparently undergoing decline, soil O_2 concentrations were generally $> 10\%$ (14 days out of 16).

Soil ODR readings, on the other hand, were generally low throughout the 16 day monitoring

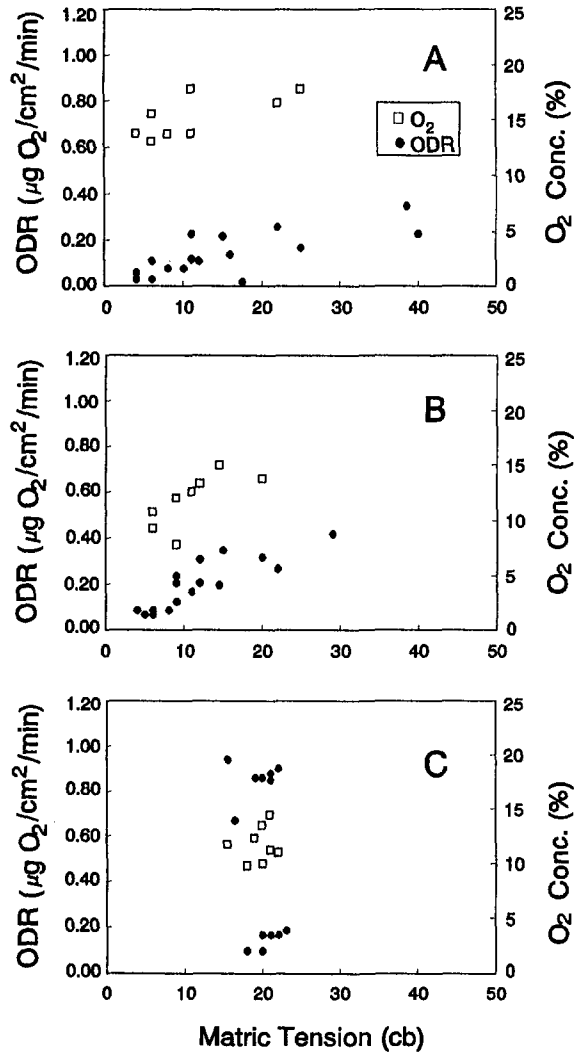

Fig. 2. Corresponding measurements of ODR and O_2 concentration at various soil depths and moisture contents at field site 1. A) 15 cm soil depth, B) 30 cm soil depth, and C) 100 cm soil depth.

period (Fig. 2). Research has shown that root growth of many plant species is retarded or prevented if ODR drops below 0.3 or $0.2 \mu g O_2/cm^2$ root min^{-1} , respectively (5, 13). At this site ODR was $\leq 0.3 \mu g O_2/cm^2/min$ during 15 of 16 days at the 15 cm depth (Fig. 2A), and 12 of 16 days at 30 cm (Fig. 2B). Indeed, ODR was $\leq 0.2 \mu g O_2/cm^2/min$ more than half the time at these depths.

Similar results were found at Site two (Fig. 3A). Again, the turf was irrigated four days per week,

and soil moisture levels were consistently high (Fig 3B). Some cycling of soil moisture was observed in the uppermost part of the profile (15 cm depth), but soil moisture at lower depths was very consistent throughout the 14 day measurement period. Soil oxygen concentration ranged between 17-21% at the 15 cm depth, and 15-18% at the 30 and 100 cm depths (Fig. 3A). But unlike Site 1, soil ODR at the 30 and 100 cm depths were relatively high (0.5-0.8 $\mu\text{g O}_2/\text{cm}^2/\text{min}$). Only in the uppermost part of the profile (15 cm) was ODR at root-inhibiting levels ($\leq 0.2 \mu\text{g O}_2/\text{cm}^2/\text{min}$) (Fig. 3A).

Taken together, the results from Sites 1 and 2 demonstrate that it is possible to have high O_2 concentrations in soil, but very low diffusion rates. Indeed, in the 15 cm zone at Site 2, ODR was very low even though O_2 concentration was essentially maximal (Fig. 3A). At both locations, trees were in states of decline (at Site 2, in severe decline). These results suggest that tree condition was not related to soil O_2 concentration per se, but was more likely related to O_2 diffusion rate. This conclusion is consistent with others (e.g., 5, 12) who have noted that, in terms of biological activity, ODR is often a more useful measure of soil oxygen status than gaseous concentration. The over-riding influence of ODR also can extend to host/pathogen interactions in soil. This was illustrated by Miller and Burke (7), who reported that *Fusarium* root rot of bean was more severe in heavily- than in normally-irrigated soils. Analysis of gas samples indicated that the O_2 concentration in the soil atmosphere was not significantly different between heavily- and normally-irrigated treatments, but ODR levels in heavily-irrigated fields dropped below $0.2 \mu\text{g O}_2/\text{cm}^2/\text{min}$ for up to 24 hrs after irrigation. Such a slow rate of O_2 diffusion to respiring roots was believed to have caused physiological stresses that predisposed roots to infection (7).

Since we found no relationship between O_2 concentration and tree condition, we did not collect or analyze O_2 samples at subsequent sites, but rather evaluated factors which influence oxygen diffusion rate through soil. Samples collected at Site 2 revealed substantial differences in soil texture and density between the surface and deeper parts of the profile. The upper (15 cm) part

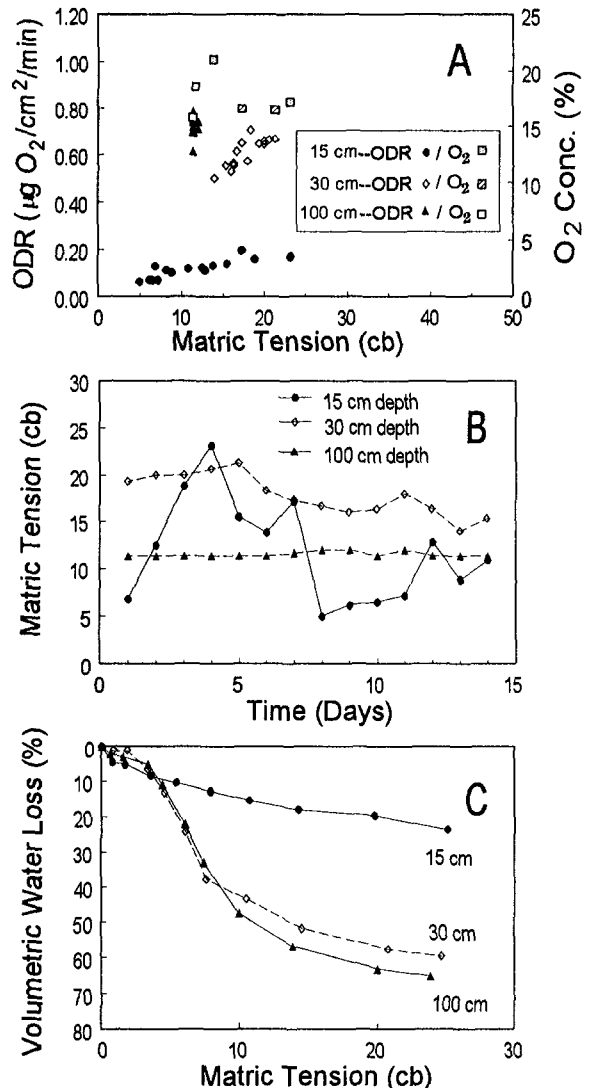

Fig. 3. Site conditions and soil features at field site 2. A) Soil ODR and O_2 measurements at 15, 30 and 100 cm depths at different soil moisture contents. B) Tensiometer readings at three soil depths over a 14 day interval. C) Soil moisture release curves for undisturbed cores recovered from 15, 30 and 100 cm depths.

of the profile had more silt and less sand than deeper (30 and 100 cm) parts of the profile, and had a higher bulk density (Table 1). Moisture release characteristics were consistent with this difference in texture and density (Fig. 3C). Cores from the upper soil layer released relatively little water in the 10 to 25 cb tension range, while those

from deeper parts of the profile drained much of their water. Thus, over the entire range of matric tensions recorded at this tree site (Fig. 3B), soil pores in the upper part of the profile would have been mostly water-filled and not conducive to oxygen diffusion.

At Site 3, where trees were vigorous, ODR was generally satisfactory ($> 0.3 \mu\text{g O}_2/\text{cm}^2/\text{min}$) at all three depths during the 10 day monitoring period (Fig 4A). The few times when ODR dropped below $0.3 \mu\text{g O}_2/\text{cm}^2/\text{min}$ occurred at the 15 and 30 cm depths, shortly after irrigations when matric tensions were $< 10 \text{ cb}$ (Fig. 4A). Irrigation-related fluctuations in soil moisture at the 15 and 30 cm

depths were greater at this tree site than at any other (Fig. 4B), and we observed a pronounced, inverse relationship between soil moisture and ODR: soil ODR was lowest following irrigation and increased sharply as the soil dried. At the 100 cm depth, soil moisture and ODR were relatively constant (55 to 65 cb and 0.3 to $0.5 \mu\text{g O}_2/\text{cm}^2/\text{min}$, respectively) (Figs 4A, 4B).

Although ODR in the upper 30 cm of soil was low when the soil was wet, this was a relatively sandy soil (Table 1) that dried quickly following irrigations (Fig. 4B). Thus, ODR was generally in a range considered favorable for root growth. Indeed, measurements of root length density (RLD)

Table 1. Physical properties of the soil at each oak tree study site.

Site	Depth (cm)	Textural Analysis ^a			Classification ^b	Bulk Density ^c	R.L.D. ^d	Restrictive B.D. ^e
		Sand	Silt	Clay				
1	10-15	40	36	24	Loam	1.49		1.50-1.60
	25-30	18	49	33	Sil. Cl. Loam	1.36		1.40-1.45
	90-100	17	54	29	Sil. Cl. Loam	1.33		1.40-1.45
2	10-15	39	46	15	Loam	1.51		1.50-1.60
	25-30	70	20	10	Sndy. Loam	1.29		1.60-1.70
	90-100	61	29	10	Sndy. Loam	1.30		1.60-1.70
3	10-15	62	14	24	Sndy. Cl. Loam	1.40	5.24	1.55-1.75
	25-30	46	26	28	Clay Loam	1.35	3.29	1.45-1.55
	90-100	33	25	42	Clay	1.32	1.22	1.40-1.55
4	10-15	52	26	22	Sndy. Cl. Loam	1.57		1.55-1.75
	25-30	57	25	18	Sndy. Loam	1.55		1.60-1.70
	90-100	29	43	28	Loam	1.48		1.50-1.60
5	10-15	26	39	35	Clay Loam	1.56	0.68	1.45-1.55
	25-30	37	33	40	Clay Loam	1.72	0.28	1.45-1.55
	90-100	25	35	40	Clay/Cl. Loam	1.30	0.11	1.45-1.55
6	10-15	23	43	34	Clay Loam	1.54		1.45-1.55
	25-30	22	43	35	Clay Loam	1.60		1.45-1.55
	90-100	21	38	41	Clay	1.19		1.40-1.55

^a Percent sand, silt and clay, by weight.

^b Textural classification. Sil.=silty, Cl.=clay, Sndy.=sandy.

^c Bulk density in g/cm^3

^d Root length density in $\text{cm root}/\text{cm}^3$ soil.

^e The bulk density at which a soil of this textural classification would be predicted to inhibit root growth (see Morris and Lowery, 1988).

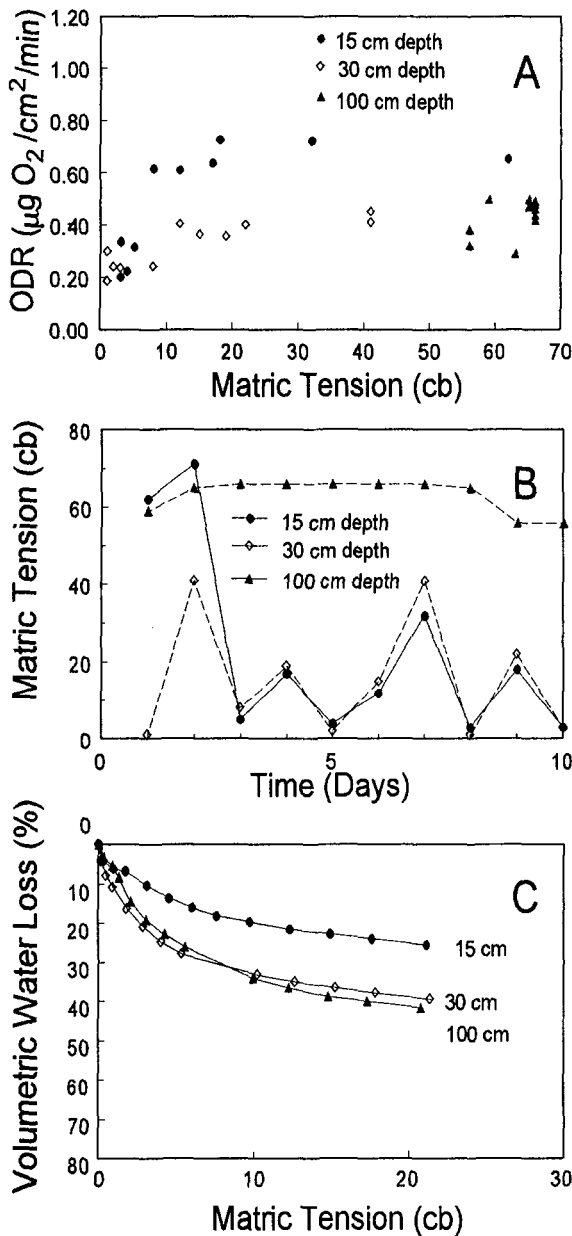

Fig. 4. Site conditions and soil features at field site 3. A) Soil ODR measurements at 15, 30 and 100 cm depths at different soil moisture contents. B) Tensiometer readings at three soil depths over a 9 day interval. C) Soil moisture release curves for undisturbed cores recovered from 15, 30 and 100 cm depths.

at this high-ODR site showed that they were almost ten times greater than at a low ODR site

(Site 5: see Fig 6 and Table 1). Interestingly, the moisture release curve for the 15 cm stratum showed that there was relatively little drainage between 0-25 cb tension (Fig. 4C). This suggests that the soil had a relatively small number of macropores that drained at low tensions, but that these apparently were adequate for oxygen diffusion.

The tree at Site 4 had extensive canopy thinning and some chlorosis. At this site, we obtained ODR readings only from the 15 and 30 cm depths (Fig. 5A), which remained very wet (< 10 cb) during the entire 13 day monitoring period (Fig. 5B). At 100 cm, the soil was relatively dry (> 50 cb) and rocky, and we were unable to insert the fragile ODR probes. In the upper soil strata, however, ODR measurements were extremely low (< 0.05 $\mu\text{g O}_2/\text{cm}^2/\text{min}$ for most readings) throughout the monitoring period (Fig. 5A). The soil bulk densities at these depths were moderately high (Table 1) for their textural class (8) and very little moisture was released from cores exposed to 25 cb tension (Fig. 5C), indicating little macropore space within these strata. Thus, the low ODR values at this site (Fig. 5A) were attributed to a combination of poor soil drainage and frequent irrigations.

At Site 5, trees exhibited severe chlorosis and some canopy thinning, and ODR values were generally low at all depths throughout the monitoring period (Fig. 6A). ODR in the 15 cm stratum increased from 0.25 to 0.45 $\mu\text{g O}_2/\text{cm}^2/\text{min}$ when matric tension increased from 2 to 35 cb, but there was relatively little change in matric tension or ODR at the 30 and 100 cm depths (Figs. 6A, 6B). ODR values were lowest (0.05 to 0.15 $\mu\text{g O}_2/\text{cm}^2/\text{min}$) at the 30 cm depth, which also had the highest bulk density (1.72 g/cm^3) of any site examined (Table 1). Soil at this site may have been compacted during construction of an adjoining building. The moisture release curves for these soils (Fig. 6C) indicated that they drained relatively little water at the matric tensions which prevailed in the field site (Fig. 6B). Thus, we again attributed low ODR values to poor soil drainage and frequent irrigations. Indeed, the only time ODR exceeded 0.3 $\mu\text{g O}_2/\text{cm}^2/\text{min}$ at this site was in the upper 15 cm stratum, when a malfunction in the irrigation system caused a brief episode of soil

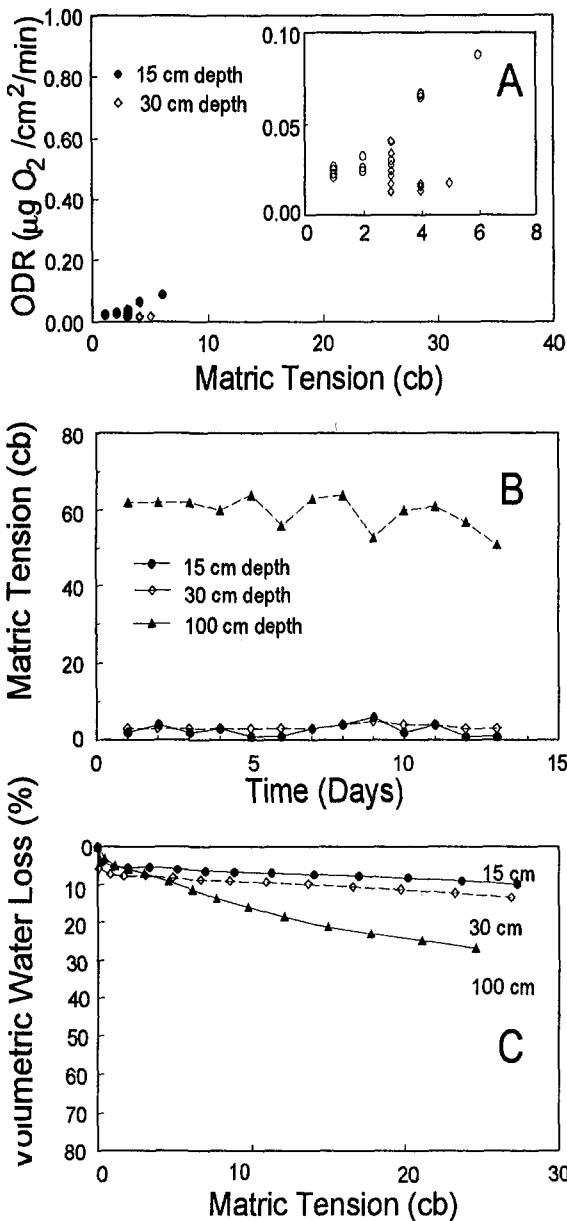

Fig. 5. Site conditions and soil features at field site 4. A) Soil ODR measurements at 15 and 30 cm depths at different soil moisture contents. Inset box shows magnified X and Y axis differentiate individual data points. B) Tensiometer readings at three soil depths over a 14 day interval. C) Soil moisture release curves for undisturbed cores recovered from 15, 30 and 100 cm depths.

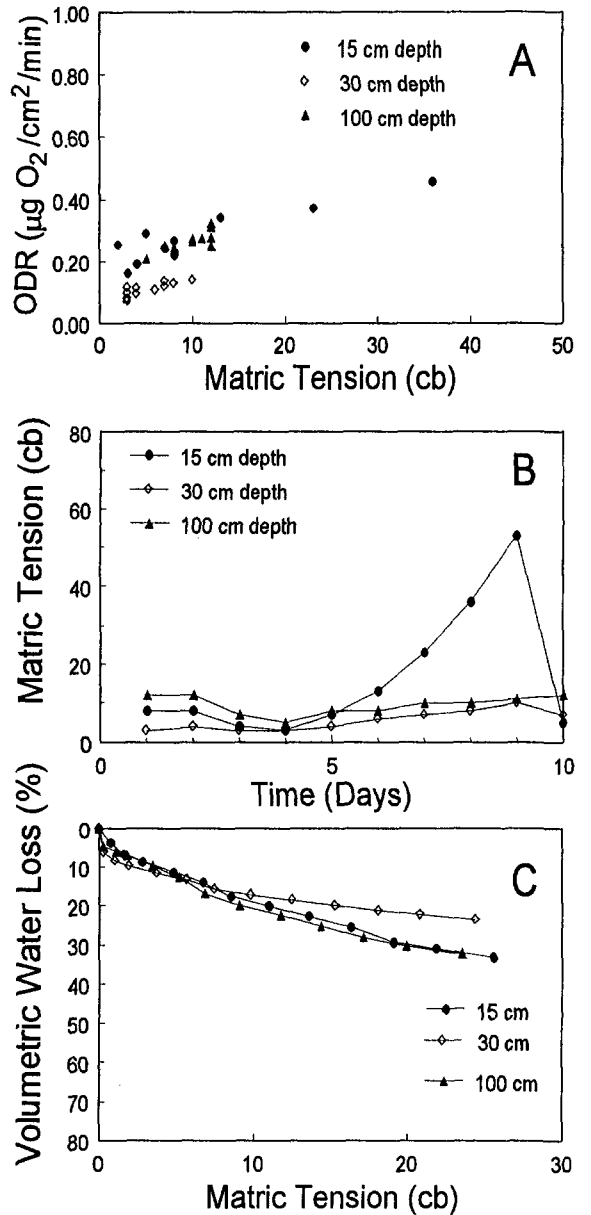

Fig. 6. Site conditions and soil features at field site 5. A) Soil ODR measurements at 15, 30 and 100 cm depths at different soil moisture contents. B) Tensiometer readings at three soil depths over a 10 day interval. C) Soil moisture release curves for undisturbed cores recovered from 15, 30 and 100 cm depths.

drying (Fig. 6B). The generally low ODR levels at this site are considered inhibitory to root growth (5, 13) and probably account for the low root length densities at this site as compared to a high-ODR site (Site 3: see Table 1, Fig. 4).

At Site 6, soil in the 15 and 30 cm strata was moist (< 20 cb), but was drier (55 to 65 cb) at 100 cm (Fig. 7A). ODR values at all 3 depths were low (< 0.2 $\mu\text{g O}_2/\text{cm}^2/\text{min}$) throughout the monitoring period. The Gro-Gun[®] treatment was applied at this site (as described in Fig. 1) five days after monitoring began. Air injection did not result in any significant change in ODR at any of the 3 measurement depths (Fig. 7B).

Summary

In our judgement, ODR was a better indicator of soil aeration (i.e., oxygen availability to roots) than was O_2 concentration. We base this conclusion on two findings: 1) The O_2 concentration in the soil atmosphere did not vary substantially at our monitoring sites over time or in response to changes in soil moisture. In contrast, ODR was strongly influenced by soil moisture and bulk density; 2) We never detected O_2 concentrations that were low enough to severely inhibit root function—even at sites where trees were declining. We did, however, detect a clear pattern relating ODR to tree condition. The ODR values within the root zones of declining trees were invariably in a range considered injurious to roots, while ODR values around vigorous trees were favorably high.

This is not the first time that O_2 concentration has been reported to be a poor predictor of plant performance, or that ODR measurements were found to better indicate oxygen availability to roots (e.g., 7, 12). Although many methods have been employed to measure O_2 concentration in soil [e.g., gas extraction and analysis (10), polarographic sensors (6), and oxidation of steel rods (2)], such measurements do not adequately describe physiological availability—the ability of O_2 to move through soil to respiring roots. ODR measurements, on the other hand, do provide an estimate of physiological availability by quantifying the rate at which O_2 moves from a source (the atmosphere) to a point of consumption (the platinum electrode). Furthermore, we found that diffusion

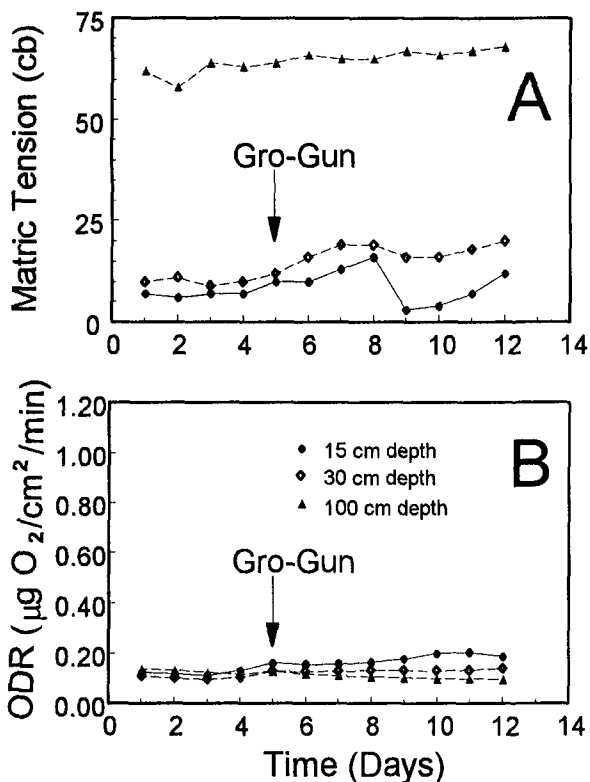

Fig. 7. Site conditions and soil features at field site 6. A) Tensiometer readings at three soil depths over a 12 day interval. B) Mean soil ODR measurements at 15, 30 and 100 cm depths over time. Arrow indicates date of air injection treatment (refer to Fig. 1 for illustration of experimental design).

rate was very strongly influenced by features of the soil environment (e.g., soil texture, density and water content), while O_2 concentration was not.

We also concluded from this study that oxygen diffusion rates in the upper soil strata (< 30 cm depth) were the most critical to oak tree vigor. This conclusion is based on our finding that at several locations where trees were declining, ODR was restrictive throughout the profile. At two decline sites, however, (Sites 1 and 2) soil ODR was restrictive only in the upper profile (< 15-30 cm depth), and was satisfactory at deeper depths (> 30 cm). Trees at one of these sites (Site 2) were in such serious condition that they were eventually removed. The critical importance of ODR within the surface strata lays in the fact that 80-

90% of the root system of most tree species develops in the upper 30 cm of soil (3, 14), and conditions in the upper profile are considered the most critical for root growth (3). We too found that root densities decreased sharply with depth, but also found that root densities of cork oaks in a high-ODR soil were ten times those in a low-ODR soil (Table 1).

There are several factors that interact to influence ODR. Soil moisture, texture, and bulk density exert the strongest influences, and often in complex interactions. For example, we found that high soil moisture did not always result in low ODR measurements. The influence of moisture is dependant upon soil texture and density, which determines the size and continuity of soil pores, and their ability to drain and allow air entry. Pore size distribution in soil is determined from moisture release curves. Thus, while ODR measurements may indicate zones of poor aeration within soil, several physical properties need to be evaluated to identify the aeration-limiting factors, and determine proper corrective actions. For example, in some cases, aeration deficits may be due solely to excessive soil moisture and may be corrected by water management alone (we found that irrigation schedules allowing soil drying had beneficial effects on ODR). In other cases, however, O₂ diffusion may be inhibited by a combination of high soil moisture and compaction. In such cases, water management alone may not increase ODR to favorable levels and other practices such as soil cultivation, core venting, or incorporation of amendments (e.g., 9,11) may be required.

The benefit of aeration enhancement practices, however, has not been clearly established. While physical disruption of the profile may increase air entry into parts of the profile (and hence increase O₂ concentration), this may not translate into improved oxygen diffusion to roots. We found no beneficial effect of Gro Gun® treatments on ODR. However, ODR at our test site probably was limited by water content as much as bulk density, and irrigation schedules were not changed following treatment. Clearly, arborists and horticulturists need to identify all factors which may limit root aeration in order to prevent or correct problems.

Acknowledgments. This research was supported in part by the Elvenia J. Slosson Endowment Fund for Ornamental Horticulture and the International Society of Arboriculture Research Trust. The authors wish to thank Tree Care, Inc., Rancho Cordova, CA for assistance with the Gro-Gun experiment.

Literature Cited

1. Birkle, D.E., Letey, J., Stolzy, L.H. and Szuszkiewicz, T.E. 1964. *Measurement of oxygen diffusion rates with the platinum microelectrode. II. Factors influencing the measurement.* Hilgardia 35:555-566.
2. Carnell, R. and Anderson, M.A. 1986. *A technique for extensive field measurement of soil anoxibism by rusting of steel rods.* Forestry 59:129-140.
3. Craul, P.J. 1992. *Urban Soil in Landscape Design.* John Wiley and Sons, New York, NY.
4. Gee, G.W. and Bauder, J.W. 1986. Particle size analysis. pp. 383-411 In Klute, A. (ed) *Methods of soil analysis. Part I: Physical and mineralogical methods.* 2nd edn. The Amer. Soc. Agron. and Soil Sci. Soc. Amer., Madison, WI.
5. Glinski, J. and Stepinewski, W. 1985. *Soil Aeration and Its Role for Plants.* CRC Press, Boca Raton, FL.
6. Meek, B.D., Donovan, T.J. and Graham, L.E. 1980. *Summertime flooding effects on alfalfa mortality, soil oxygen concentrations, and matric potential in a silty clay loam soil.* Soil Sci. Soc. Am. J. 44:433-435.
7. Miller, D.E. and Burke, D.W. 1977. *Effect of temporary excessive wetting on soil aeration and Fusarium root rot of beans.* Plant Dis. Reporter 61:175-179.
8. Morris, L.A. and Lowery, R.F. 1988. *Influence of site preparation on soil conditions affecting stand establishment and tree growth.* South J. Applied For. 12:170-178.
9. Pittinger, D.R. and Stamen, T. 1990. *Effectiveness of methods used to reduce harmful effects of compacted soil around landscape trees.* J. Arboric. 16:55-57.
10. Rolston, D.E. 1986. Gas flux. pp. 1103-1119 In Klute, A. (ed) *Methods of soil analysis. Part I: Physical and mineralogical methods.* 2nd edn. The Amer. Soc. Agron. and Soil Sci. Soc. Amer., Madison, WI.
11. Smiley, E.T., Watson, G.W., Fraedrich, B.R. and Booth, D.C. 1990. *Evaluation of soil aeration equipment.* J. Arboric. 16:118-123.
12. Stolzy, L.H. 1974. Soil atmosphere. pp 335-361 In Carson, E.W. (ed) *The plant root and its environment.* Univ Press Virginia, Charlottesville, VA.
13. Stolzy, L.H. and Letey, J. 1964. *Measurement of oxygen diffusion rates with the platinum microelectrode. III. Correlation of plant response to soil oxygen diffusion rates.* Hilgardia 35:567-576.
14. Watson, G. 1985. *Tree size affects root regeneration and top growth after transplanting.* J. Arboric. 11:37-40.

Department of Plant Pathology
University of California
Davis, CA 95616

Résumé. L'étude des conditions de sol autour de chênes vigoureux et d'autres dépérissants dans les zones urbanisées de la Californie a révélé que l'aération de la strate supérieure du sol était l'élément le plus critique à la vigueur de l'arbre. Il a été aussi découvert que les mesures du taux de diffusion de l'oxygène donnaient un meilleur indice de la disponibilité en oxygène dans le sol que les mesures de concentration en oxygène. Le taux de diffusion de l'oxygène était le moins élevé dans les sols avec une forte densité et un haut taux d'humidité. Dans un sol restreint (tassé, etc.), le taux de diffusion d'oxygène n'augmentait pas significativement après des injections d'air conçues pour relâcher la structure du sol.

Zusammenfassung. Die Untersuchungen der Bodenverhältnisse um gesunde und kranke Eichen in einem Stadtgebiet in Kalifornien verdeutlichen, daß die Bodenbelüftung in den oberen Bodenschichten aufschlaggebend für die Lebensfähigkeit der Bäume ist. Man fand auch heraus, daß Messungen über die Sauerstoffverteilung im Boden einen besseren Überblick darüber gab, wieviel Sauerstoff im Boden zur Verfügung stand, als Messungen über die Sauerstoffkonzentration. Die Sauerstoffverteilung war am geringsten in Böden mit hoher Massendichte und hohem Feuchtigkeitsgehalt. In kargen Böden stieg die Sauerstoffverteilung nach einer Bodenbelüftung zur Strukturverbesserung durch Injektionen nicht wesentlich an.