

JOURNAL OF ARBORICULTURE

August 1979
Vol. 5, No. 8

SURVEY OF URBAN TREES IN BRUSSELS, BELGIUM¹

by R.A. Impens and E. Delcarte

Brussels will next year celebrate the first millenium of its creation. The capital of the European common market and covering an area of 138 km², Brussels has more than one million inhabitants. The town is divided in 19 districts. Each of them enjoys a separate administration, including a separate municipal planting service, and different policies for green spaces.

Brussels has a total of 28 m² of green space per inhabitant as compared to Paris where each of the 2.6 million residents enjoys only 7.5 m² of green space.

The urban growth of Brussels, and of other Belgian cities as Antwerpen, Brugge, Ghent, Liege, and Charleroi, has engulfed, like a hungry amoeba, a lot of green space such as forests, fields and meadows, parks and historical or private gardens. These areas are exposed to many causes of decline. It is not so much the pressure of traffic, air pollution or climatic changes as the pressure of city expansion and the economic value of building sites.

In the past 10 years, our cities have suffered a major loss of trees. This was due in part to a decline with numerous causes. Natural gas leakages in soil, air pollutants, and heavy metals were the factors most incriminated for the observed symptoms and death of shade trees.

Street tree surveys

A study on the causes of death in the trees growing in the Brussels metropolitan area began in 1973. Our laboratory, devoted to plant physiology, was associated with the Ecologie-Recherche-Amenagement (E.R.A.) action. At first

we were busy studying the effects of air pollutants and heavy metals on trees. Since July 1975, our investigations have been assisted by a grant from the Institute for Applied Research in Agriculture and Industry (I.R.S.I.A.) and we were able to initiate a more comprehensive research program.

Information we felt important for planning and developing our investigation included: 1) the structure and composition of street tree populations, 2) the optimum site for the different species, and 3) the distribution of declining trees. This survey required a complete street tree census, which was repeated every year. Such an expensive census was necessary because of the rapid change in the plantings. Every year, 3,000 to 4,000 young trees are planted to replace dead trees or to create new rows.

The characterization and distribution of species revealed more than 80 different species in Brussels' 19 districts and totaled 81,000 trees. The most represented species are listed in Table 1. The distribution pattern shows the low concentration of street trees in the heart of the city, and high concentrations in the outlying residential suburbs. This distribution is not the best, because most of the houses in the outlying areas of the town are surrounded by gardens which are serving well their role as dust filters. It is in the oldest part of the city that green spaces are most necessary for cleaning the atmosphere (Fig. 1).

The survey of each tree's condition is made two times every year. It includes observations of foliage (necrosis, chlorosis, discoloration, wilting, general aspect, etc.), stems and limbs with a special interest in disease symptoms or declines,

¹Presented at the annual conference of the International Society of Arboriculture in Toronto, Ontario, Canada in August 1978.

and the noting of the dates of budding, flowering, fruiting, and leaf falling.

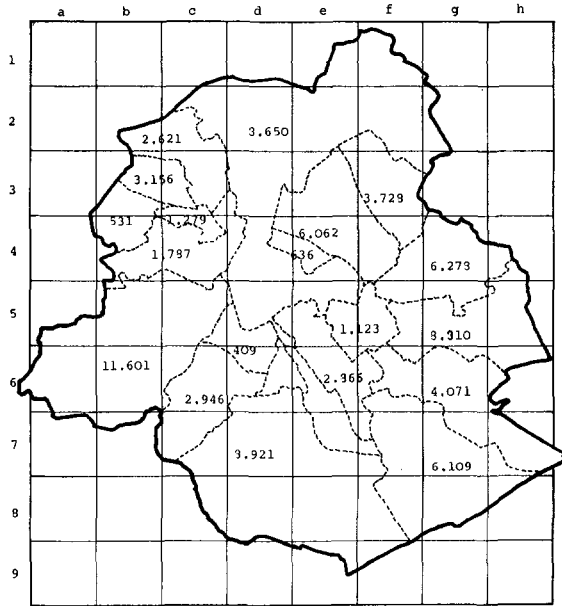

Fig. 1. Census of shade trees in Brussels in 1977 (81,581 trees). Number of shade trees in each of the 19 districts.

The trees are classified in three condition classes: healthy, declining, and dead trees. Every year we find approximately 3% dead and 5% declining trees (Table 2).

The young trees' behavior is observed during their first year of establishment in the city. Their rate of growth is measured each month. Particular note is taken with the young trees that are planted

to replace dead trees, where the soil has only rarely been removed and planting conditions are as bad as they were previously. Soil conditions cause a high death rate among these young trees (Table 3). Results in 1976 were very bad. The dry summer killed a lot of recently planted trees (19.5%).

These observations have shown that tree species behave very differently under urban conditions. After 5 years' study, we have selected some resistant species of trees that are adapted to the Brussels environment. We recommend for planting: *Populus euramericana*, *Platanus acerifolia*, *Robinia pseudoacacia*, *Ulmus glabra*, and different species of *Malus* and *Crataegus*.

The most fragile species have been recognized in the same way: *Quercus rubra*, *Acer pseudoplatanus*, *Acer saccharum*, and *Tilia platyphylla*.

Observations on the health of trees have been mapped for each species. This pattern of mapping shows the differences in hardiness and allows the marking of areas where conditions for a chosen tree species require particular attention.

Street tree survival or death is the result of a complex action of hostile environment including vandalism, air pollution, soil disruption and compaction, gas injury, anaerobic conditions for the roots, nutrient imbalance, moisture deficiencies and excesses, deicing salts, pesticides, etc. Our investigations include ecological or field observations with simulation experiments carried out in the laboratory including abundant sampling and many analyses.

Table 1. The ten major tree species in Brussels (1977)

| | Number | % of total | Healthy % | Decaying % | Dead % |
|-------------------------------------|--------|------------|-----------|------------|--------|
| <i>Platanus acerifolia</i> (Ait) W. | 9,953 | 12.2 | 96.2 | 1.8 | 2.0 |
| <i>Prunus serrulata</i> Ldl | 9,912 | 12.1 | 93.2 | 4.0 | 2.8 |
| <i>Robinia pseudoacacia</i> L. | 7,441 | 9.1 | 95.1 | 2.4 | 2.5 |
| <i>Acer platanoides</i> L. | 5,641 | 7.0 | 92.4 | 3.6 | 3.0 |
| <i>Tilia platyphylla</i> Scop. | 5,500 | 6.7 | 93.9 | 4.4 | 1.7 |
| <i>Aesculus hippocastanum</i> L. | 4,652 | 5.7 | 96.0 | 2.6 | 1.9 |
| <i>Prunus cerasifera</i> Ehrh. | 4,363 | 5.3 | 97.1 | 1.8 | 1.1 |
| <i>Acer pseudoplatanus</i> L. | 3,952 | 4.8 | 94.5 | 4.5 | 1.0 |
| <i>Populus nigra</i> L. | 2,903 | 3.6 | 96.7 | 2.1 | 1.2 |
| <i>Crataegus oxycantha</i> L. | 2,730 | 3.3 | 97.6 | 1.0 | 1.4 |

Table 2. Census and health's conditions of street trees in Brussels metropolitan area

| Year | Total of trees | Healthy | | Decaying | | Dead | |
|------|----------------|---------|---------|----------|---------|--------|---------|
| | | Number | Percent | Number | Percent | Number | Percent |
| 1974 | 75,653 | 69,576 | 92.0 | 3,943 | 5.2 | 2,137 | 2.8 |
| 1975 | 80,493 | 76,512 | 95.0 | 1,918 | 2.4 | 2,063 | 2.6 |
| 1976 | 82,374 | 77,211 | 93.7 | 2,487 | 3.0 | 2,676 | 3.3 |
| 1977 | 81,581 | 77,474 | 95.0 | 2,522 | 3.1 | 1,585 | 1.9 |

Table 3. Census and health conditions of young street trees in Brussels metropolitan area (new plantations)

| Year | Total of trees | Healthy | | Decaying | | Dead | |
|------|----------------|---------|---------|----------|---------|--------|---------|
| | | Number | Percent | Number | Percent | Number | Percent |
| 1974 | 2,300 | 2,088 | 90.8 | 62 | 2.7 | 150 | 6.5 |
| 1975 | 3,710 | 3,176 | 85.6 | 152 | 4.1 | 382 | 10.3 |
| 1976 | 3,148 | 2,389 | 75.8 | 138 | 4.4 | 621 | 19.7 |
| 1977 | 2,463 | 1,914 | 77.7 | 136 | 13.6 | 213 | 8.7 |

By the end of 1975, we had created a network of ecological observations (20 sampling sites are disseminated in the Brussels area, and others are in rural areas). In each site, there is an Owen deposit gauge and a vaseline plate to collect airborne particles. Other devices measure and collect the water running down the trunks of trees while classical meteorological parameters are also measured (Figures 2 and 3).

Each month, samples of the rain and stem-flow waters are collected. The following determinations are made: quantity, pH, total soluble and insoluble materials, the SO_4 content (measured by turbidimetry), Cl (measured by a selective electrode) and the trace-elements Pb, Cd, Cu, Zn, and Ni (analyzed by differential pulse polarography).

The dusts collected on the vaseline plates are weighed after elimination of the vaseline (by an extraction with petroleum benzene) and their contents in Pb, Cd, Cu, Zn, and Ni are determined by differential pulse polarography. In each site, samples of leaves are collected and analyzed for their metal contents.

If we divide our 20 sites in three different groups, the first includes urban gardens,

backyards, and schools (6 stations), the second includes urban park, cemetery, and nursery gardens (6 sites), the last one with 8 sites along the streets, we find differences in heavy metal contamination.

Analysis of results are summarized in Table 4 and compared to those obtained with samples collected in rural areas. The dust content is two or three times more important in the street sites than elsewhere. The mean contents in metallic particles resulting from typical urban pollution (i.e., Pb, Cd, Zn) vary according to the traffic density. The same observations were made when we used street trees as bioindicators of the urban air pollution.

With our network, we noticed during the dry summer of 1976, some "heat islands" in our city, and a particular pattern of rainfall.

Soil analyses

Brussels' soils are very heterogenous, with sand and clay on the hills and loam in the valleys. Each year we analyze the composition of about 2,000 soil samples.*

Imbalances in the major elements that are

*Determinations of major elements in the soil are made by our colleague Dr. M. Verloo, from the Faculty of Agronomic of Ghent who collaborates on the E.R.A. program.

necessary for plant growth are rarely observed. Eventually, fertilization may be needed to correct a deficiency in nitrates or phosphates. But presence of chloride, due to deicing salts, is more frequent and is a major problem. The soils' redox potential and pH are also measured. Soils are generally basic (in more than 90% of the cases the pH is higher than 7.0).

The oxidation-reduction status of the soil is closely related to the soil gas-phase composition. Under anaerobic conditions, nitrates, iron, manganese, and sulfates can be reduced, and these reduced compounds characterize anaerobic urban soils. Presence of sulfides (more than 10 ppm in 40% of the samples), reduced manganese, and nitrites is nearly always cor-

VASELINE PLATE

- Dusts : mg/dm²/day.
- Pb, Cu, Ni, Zn : µg/dm²/day.

OWEN GAUGE

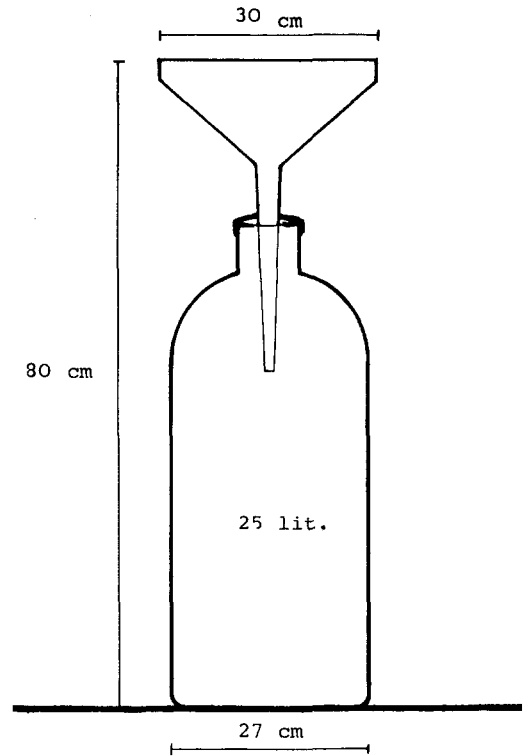
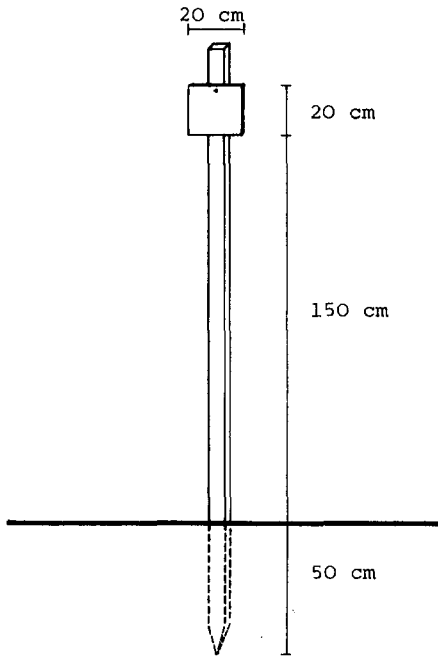

Periodicity = 30 days

Fig. 2. Equipment used at the 20 sampling sites to collect airborne particles and rainfall.

Table 4. Mean contents in total dusts and metallic particles collected each month on the vaseline plates

| Group | Total dusts | Pb | Cu | Cd | Ni | Zn |
|--------------|-------------|-----|-----|-----|----|-----|
| 1 backyards | 444 | 293 | 84 | 2.2 | 19 | 208 |
| 2 parks | 555 | 218 | 55 | 1.2 | 13 | 236 |
| 3 street | 1,162 | 650 | 145 | 3.7 | 45 | 488 |
| 4 rural area | 552 | 91 | 26 | 0.2 | 6 | 74 |

Results of total dusts in microgr/dm²/day, heavy metals in nanogr/dm²/day.

related with declining or dead trees. Measurements of the redox potential may give information on the oxidation-reduction status of the soil, but correct data are difficult to obtain in streets, and they must be interpreted with caution.

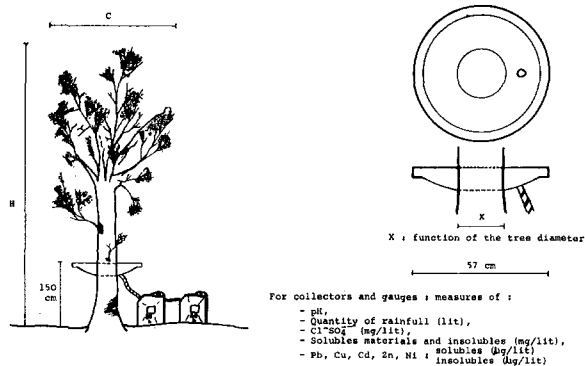

Fig. 3. Equipment used to collect and measure water running down the trunks of trees.

Reduction and oxidation processes in soil are associated with change in pH. During a reductive stage, shifts in pH are observed.

Poor aeration conditions in the soil may result from impeded exchange between the soil gas-phase and the atmosphere (e.g., due to a sealed soil surface by flag pavements, asphalt or concrete), soil compaction, and natural gas leakages, or from exceptionally high biological activity in the soil (e.g., resulting from a gas leakage).

An important part of our research program is to identify, prevent, and cure such cases of anaerobic soils. Every year more than 3,000 analyses of the soil gas-phase are made near declining or dead trees. The most important gas components in urban soils are methane, oxygen, and carbon dioxide. The concentration of these gases in percent of volume are measured periodically for 600 indicator trees.

Anaerobic soil conditions, whatever their causes may be, are especially disastrous for trees. Root growth is stopped while root respiration and uptake of water and nutrients are reduced.

Water balance in soil is important, too. Soil moisture is checked monthly and assessed in relation to the amount of rainfall. Water stress is one

of the most important factors of mortality for urban vegetation, and particularly for young trees. Water deficiency occurring in the summer is very damaging in towns, especially if the winters' rainfall contribution was low. In a few districts of Brussels, trees are watered in summer. Chemical properties of the added water are tested.

The minor elements required for plant life are studied in plant analyses to detect any deficiency. Indicators of pollution by heavy metals are reported too (Pb and Cd, for example). There are close relationships between the amounts of lead found on the leaves and the amount of traffic at the sampling site.

Simulation studies

Simultaneously, and correlated with the field observations and measurements, simulation experiments are carried out in the laboratory. Ongoing research includes the effects of air pollutants. Sulfur dioxide is the most commonly reported air pollutant in the Brussels area. We are testing, with an air pollution chamber, the relative sulfur dioxide tolerance of some commonly planted shrubs and shade tree cultivars.

Our fumigations are made with different concentrations of SO_2 but with a constant product concentration and time. Examination of foliar response, extent of foliar injury, and for short-term high-concentration exposure, growth reduction and mortality are examined. The sulphur content of fumigated leaves is analyzed. We would like to measure simultaneously the rates of photosynthesis reduction by SO_2 or other pollutants, but unfortunately, our equipment is not large enough to experiment with tree seedlings.

These fumigation experiments will be extended to other pollutants (nitrogen oxides). They are designed to give information on the relative air pollution tolerances of the more common trees in the Belgian cities, and to select some air-pollution resistant trees. These selected trees will be used in resistance breeding programs.

Other simulation experiments are devoted to the microbial oxidation of natural gas components in the soil and to the microorganisms involved in this process. An artificial leak is created by inserting iron tubing reaching a depth of 80 cm below the

soil surface and bleeding natural gas or nitrogen at controlled rates, varying between 70 and 100 liter per hour, as checked with a flow-meter, in containers filled with 1 m³ of a mixture of sandy soil and clay. Oxygen deficiency is monitored and the reduction of sulfates is observed and measured.

Soil samples for microbiological analyses are collected every week. Plate counts of heterotrophic bacteria and of bacteria oxidizing natural gas are performed. Strains of these oxidizing bacteria were isolated and identified as *Enterobacter cloacae*.

As a result, total nitrogen content of soil, pH, and anaerobic proteolytic microflora were increased and soil structure was modified. Indicators of a reduced state in soil were present and these were analyzed (sulfides, Mn). We intend to identify the compounds that are harmful to the root system of a tree and are formed as a result of microbial activity. The restoration of the soil's aerobic condition is important for the replanting of young trees after repair of the natural gas leak.

Pilot study

Avenue Heydenberg was chosen as an experimental plot to improve our means of urban tree survival and to exhibit new processes of planting. There were 74 *Robinia pseudoacacia* in the Avenue, most of them were declining. Some of them suffered a drastic treatment. The planting pit was enlarged to 1.5 X 1.5 m. The anaerobic soil was changed or aerated with four ventilation channels. Nutrients, organic matter (manure), and water were provided, and ground cover plants were established. Other trees were not treated.

This pilot experiment began in the spring of 1976. Regular analyses are made of nutrients, soil moisture, soil gas-phase composition, and foliar analysis. Results are hopeful. The survival of the treated trees is secured. Growth of the stems increases. Leaves are healthy and larger, and the general appearance of treated trees is pretty good.

Unfortunately, the cost of a young tree so planted and so treated is approximately \$200 to \$300. It is expensive for our district managers and politicians. Actually, 4 more plantations need the same expensive yet efficient treatment.

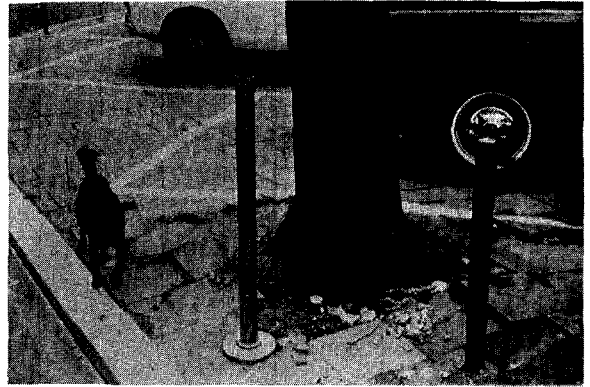

Fig. 4. There is a competition for space between cars, concrete, signal posts, pavements, dogs and trees.

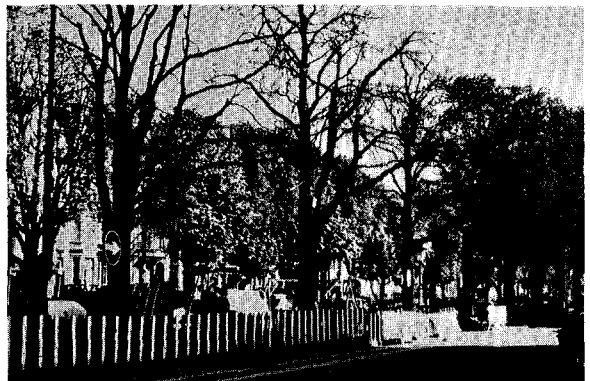

Fig. 5. Horse chestnut trees (avenue de Tervuren) during construction for underground building.

Some trees, especially *Platanus acerifolia*, decline due to contamination of street-side soils by winter deicing salts (NaCl and CaCl₂). During the dry summer of 1976, salt injury to trees and grasses was frequent in sites where lawns and shrubs were planted above underground parkings, with soil 30 cm in depth.

A special study was made with a device for collecting soil and water samples containing the deicing salts. The devices were placed near highways and near heavy traffic streets. A periodical accumulation of Cl was noted.

Discussion

Our investigations, carried out in Brussels and in different Belgian towns, show how complex the ecological and technical factors are in affecting the survival of street trees. E.R.A.'s research program is devoted to a better knowledge of urban

tree growing conditions, and it provides good information for arboriculturists, and a coherent policy for green spaces.

Protection and extension of shade trees and green spaces in cities and industrial areas need not only research or financial contributions, but also laws protecting the existing vegetation. Technical problems must be dealt with in multidisciplinary teams where ecologists, arboriculturists, analytical chemists, and plant physiologists will work together with City engineers and City planners.

Belgian municipal arboriculturists (called "chefs de plantation") are informed of our investigations by our "Bulletin de l'E.R.A.," edited four times a

year in French and Dutch. Twice a year, special educational meetings are organized where E.R.A.'s research workers and practitioners may talk over their problems of tree survival and how to resolve them.

E.R.A. is an adviser and a consultant as well as a research laboratory. We are convinced that our actions must be extended even further with cooperation and information given to foreign colleagues.

I hope, and I am sure, that my presence at the I.S.A. convention will be the beginning of an exchange of information and collaboration between the International Society of Arboriculture and the Belgian E.R.A.

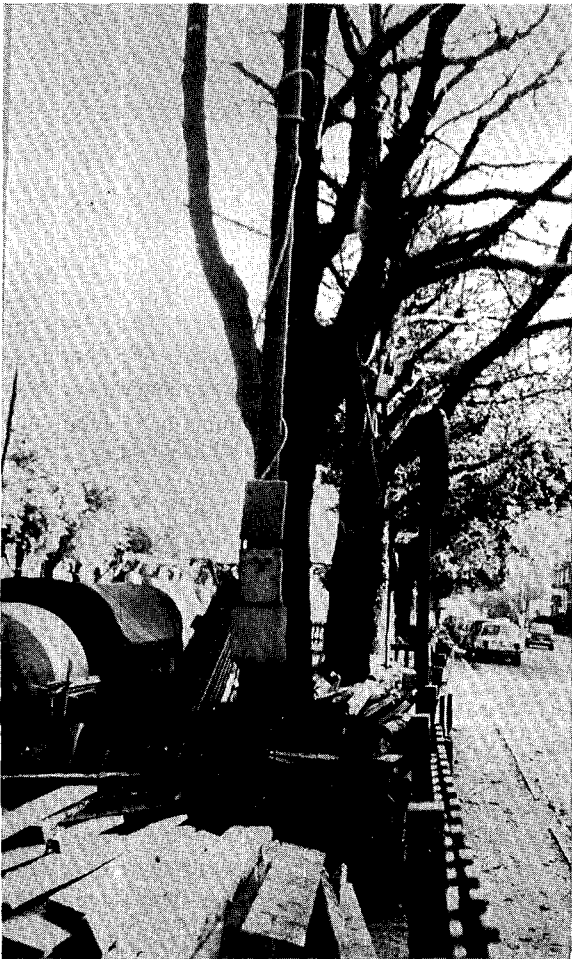

Fig. 6. City engineers are a frequent cause of tree decline.

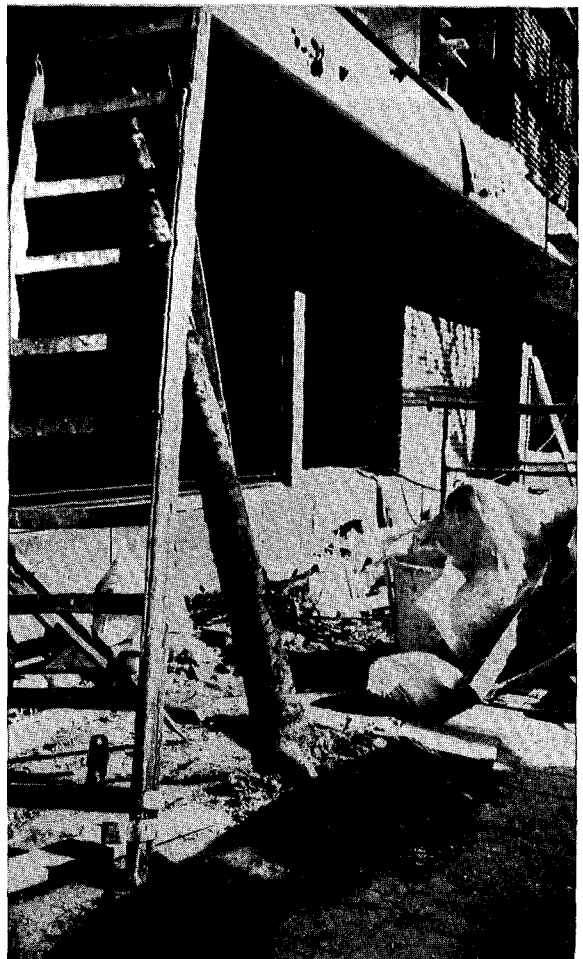

Fig. 7. Building houses without consideration for the trees.



Fig. 8. Pilot plantation of a young plane tree in Woluwe-Saint-Lambert, with flowering plants covering the soil.

ETUDE SUR LES CONDITIONS DE VIE DES ARBRES A BRUXELLES, BELGIQUE

Depuis 1972, une étude sur les conditions de vie des arbres d'alignement se poursuit à Bruxelles. Elle comprend un inventaire des arbres et la surveillance de leur état sanitaire.

Un réseau d'observations éco-climatologiques, des analyses du sol (éléments majeurs et métaux lourds) et de l'atmosphère du sol (O_2 , CO_2 , et CH_4), permettent de mieux connaître les conditions de vie des arbres en ville.

Au laboratoire, des essais de fumigation artificielle (SO_2) et de gazage (CH_4) en conditions contrôlées ont pour buts d'étudier la réaction des arbres à ces agressions.

Des plantations pilotes sont conçues en fonction des travaux du laboratoire et des observations sur le terrain.

Department de Biologie Végétale Théorique et Appliquée, Faculté des Sciences Agronomiques de l'Etat. B-5800 Gembloux, Belgique, and Ecologie-Recherche-Amenagement (E.R.A., Asbl, 7 rue Souveraine, 1050 Bruxelles, Belgique.

ABSTRACT

Shurtleff, Malcolm. 1978. **Control of pests and diseases of ornamentals.** *Grounds Maintenance* 13(5): 46, 48, 62, 64.

Control of insects and plant diseases is an essential part of grounds maintenance. Battling pests is insurance to prevent loss of time and money caused by uncontrolled outbreaks of diseases and insects. The following tables will aid in correct diagnosis of pests and diseases. There are two types of control measures: cultural or biological, and chemical. Both types are needed. Common sense rules for reducing pest problems without the use of chemicals focus on sound gardening practices. When cultural practices do not adequately suppress insects and diseases, utilize chemical applications. The pesticides listed in the tables are the most effective and safe materials available.